

A

A

B

B

C

C

D

D

GPS

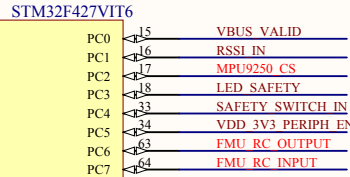
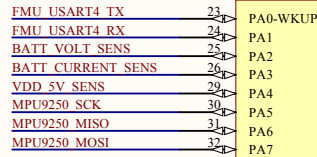

FrSky INV U1202 pin 1

PB0 and PC7 are both RC\_INPUT

8266 GPIO2 added here BRICK\_VALID is now Active HIGH

USART1 is for ESP8266

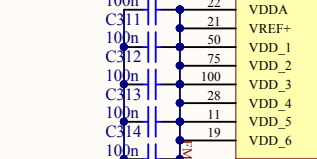
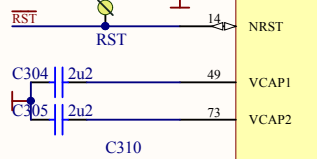
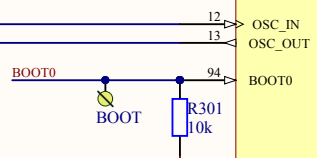
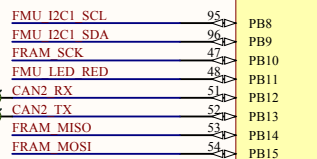
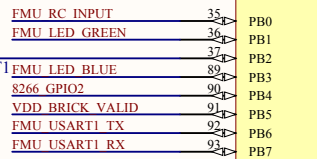
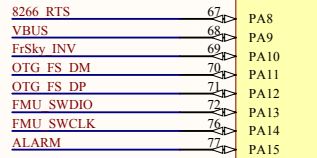
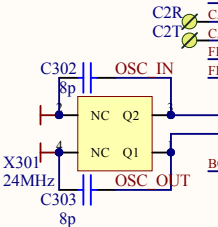
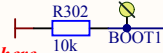

Cannot open file C:\Users\ARSOW\Desktop\vrem\oshw-logo.bmp

VBUS\_VALID is now Active HIGH

Enables 3V3 for 8266 and Spektrum

PB0 and PC7 are both RC\_INPUT

SBUS inverted with active HIGH (U1203)

TELEMETRY1

TELEMETRY2 / OSD

FrSky

Powers the Spektrum satellite

SERIAL DEBUG

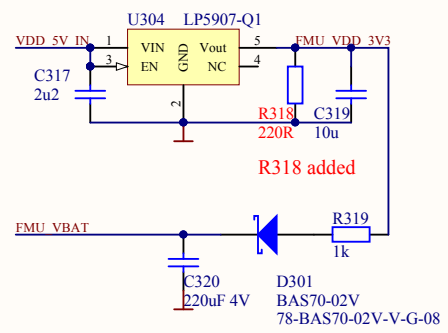
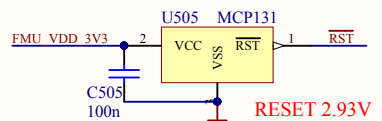
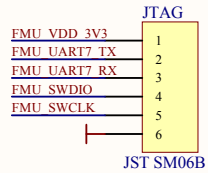
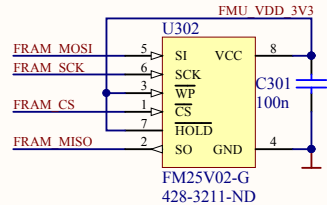

Title		PIXRACER-V1-FMU	AUAV.CO
Size	Number	DEC-06-2015-1330	Revision
A4			RC12
Date:	06.12.2015	Sheet of	3 of 5
File:	F:\fwdsch\PIXRACER-FMU-R09.SchDoc	Drawn By:	Nick Arsov

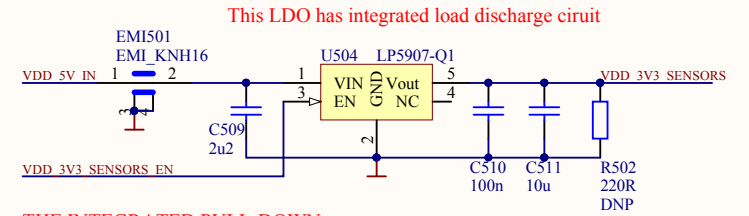
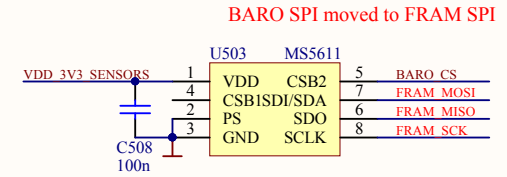
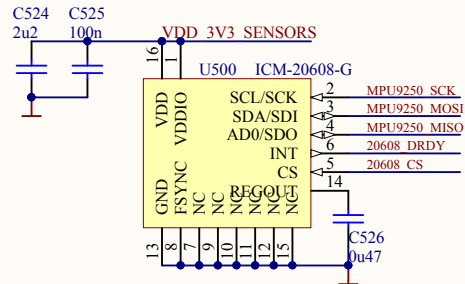
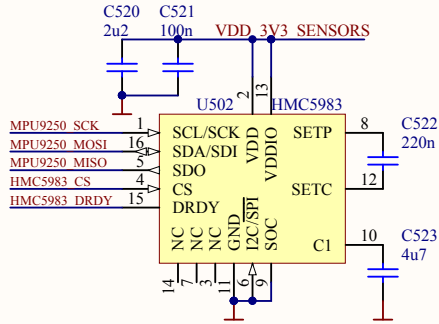
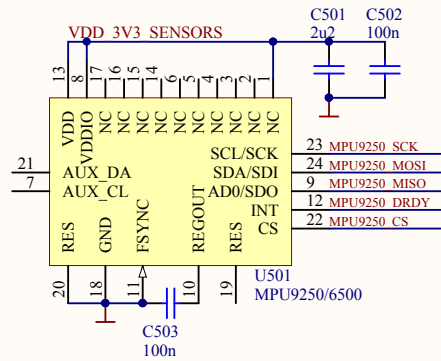

**THE INTEGRATED PULL-DOWN  
DISABLES THE VDD\_3V3\_SENSORS AT POWER ON**

**This LDO has integrated load discharge circuit**

**BARO SPI moved to FRAM SPI**

Cannot open file  
C:\Users\ARSOV\Desktop  
\vrem\oshw-logo.bmp

Title		PIXRACER-V1-IMU		AUAV.CO	
Size	Number	DEC-06-2015-1330		Revision	RC12
Date:	06.12.2015	Sheet of	5 of 5		
File:	F:\fwdsch\PIXRACER-IMU-R09.SchDoc	Drawn By:	Nick Arsov		

**R104 prevents rev current of D101 when USB is disconnected**

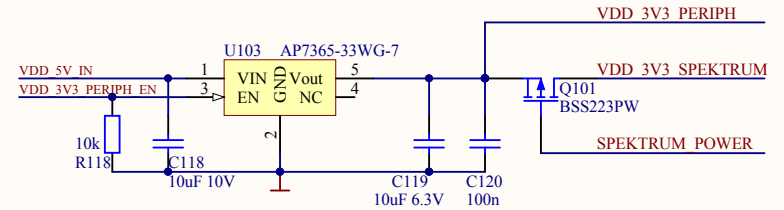
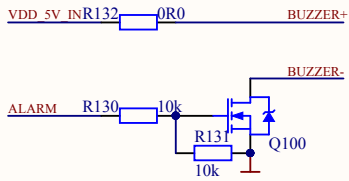
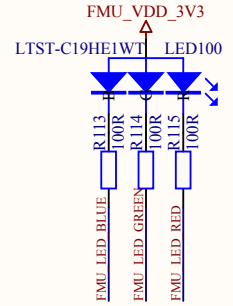
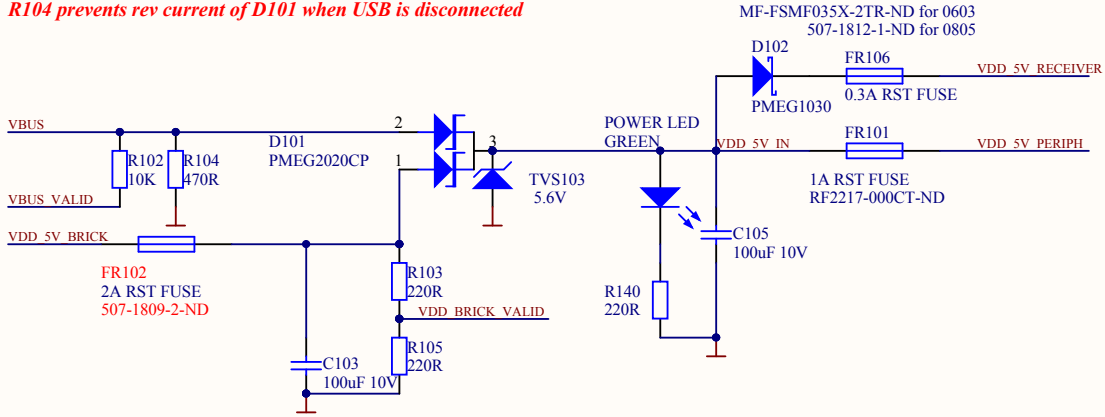

Cannot open file  
C:\Users\ARSOV\Desktop  
\vrem\oshw-logo.bmp

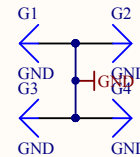
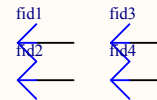

Title		PIXRACER-V1-POWER		AUAV.CO	
Size	Number	DEC-06-2015-1330		Revision	RC12
Date:	06.12.2015	Sheet of	1 of 5		
File:	F:\fwdsch\PIXRACER-POWER-R09.SchDoc	Drawn By:	Nick Arsov		

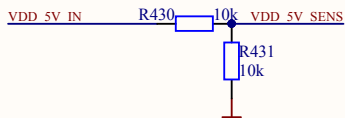
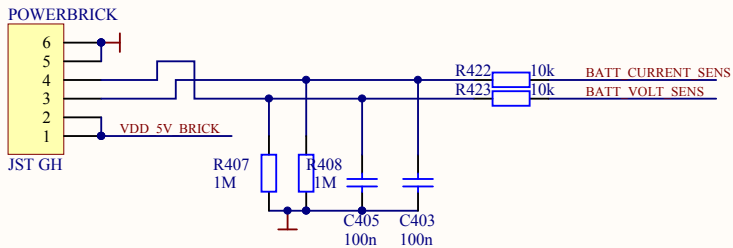
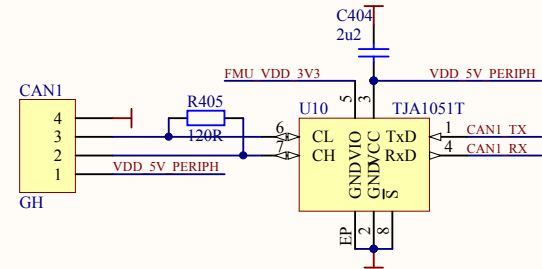
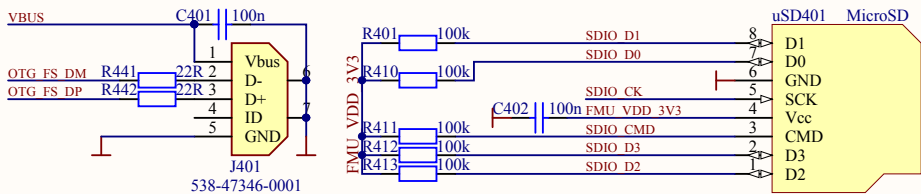

Cannot open file  
 C:\Users\ARSOW\Desktop  
 \vrem\oshw-logo.bmp

Title		PIXRACER-V1-SD-USB-CAN-I2C	AUAV.CO
Size	Number	DEC-06-2015-1330	Revision
A4			RC12
Date:	06.12.2015	Sheet of	4 of 5
File:	F:\fwdsch\PIXRACER-SD-USB-R09.Sch	Drawn By:	Nick Arsov

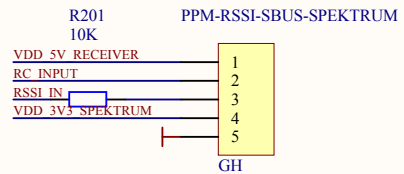

*RC\_INPUT is for any of PPM/SBUS/SPEKTRUM*

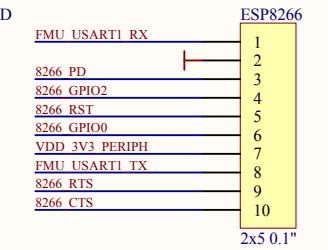
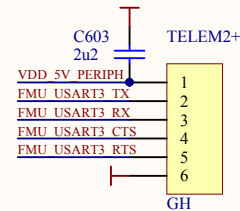
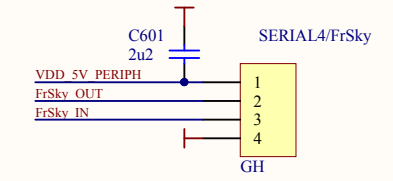
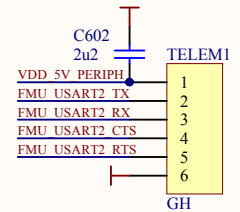
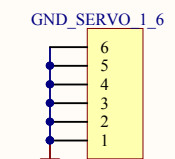
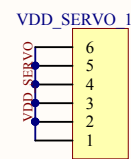
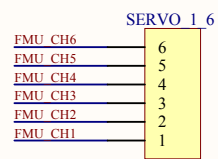
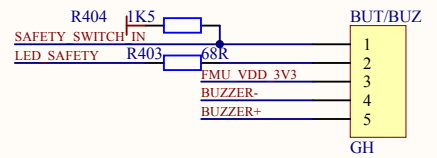
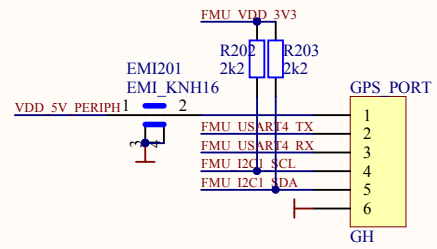
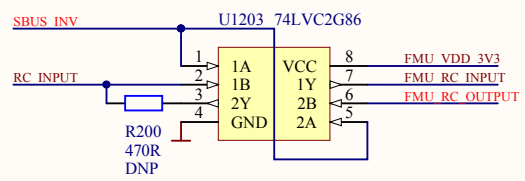

*FrSky inverter*

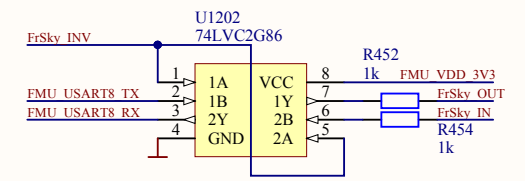

Cannot open file  
C:\Users\ARSOW\Desktop  
\vrem\oshw-logo.bmp

Title		PIXRACER-V1-SERIALS	AUAV.CO
Size	Number	DEC-06-2015-1330	Revision
A4			RC12
Date:	06.12.2015	Sheet of	2 of 5
File:	F:\fwdsch\PIXRACER-SERIALS-R09.Sch	Drawn By:	Nick Arsov